

















# INSTALLATION MANUAL

10109FD

LED BUILT IN    DARK LIGHT   | CE EAC UK CA      120mm  
230V | SMD LED | 9W | IP65 | Die cast | 90 CRI   230V    111mm  80mm  58mm



A

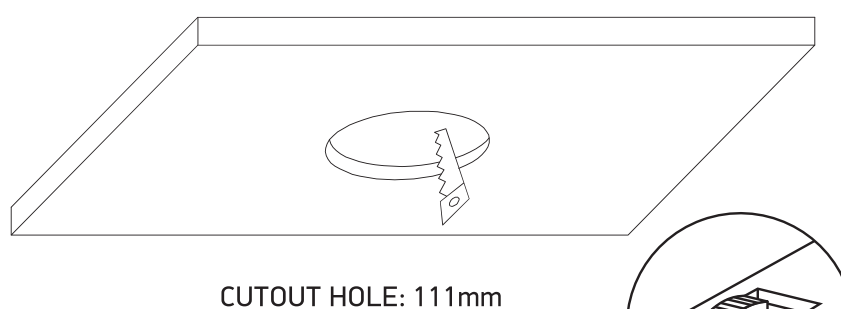

B

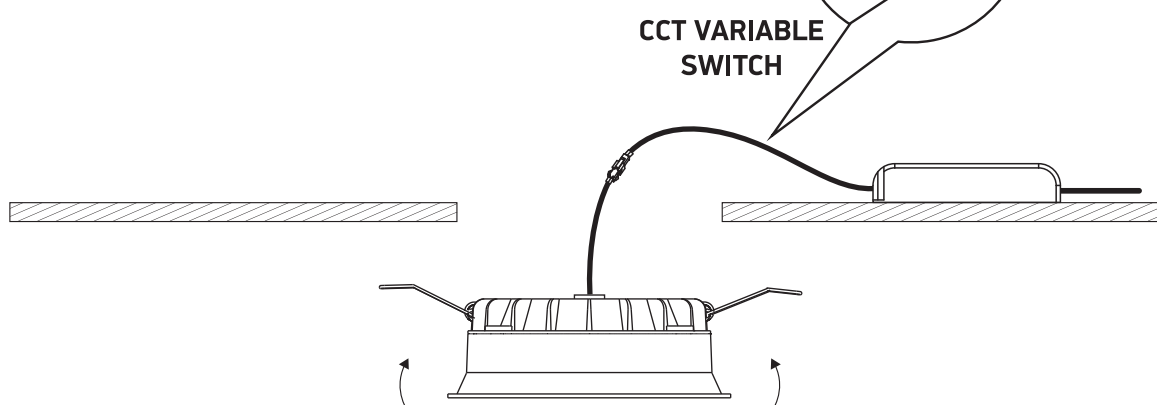

C

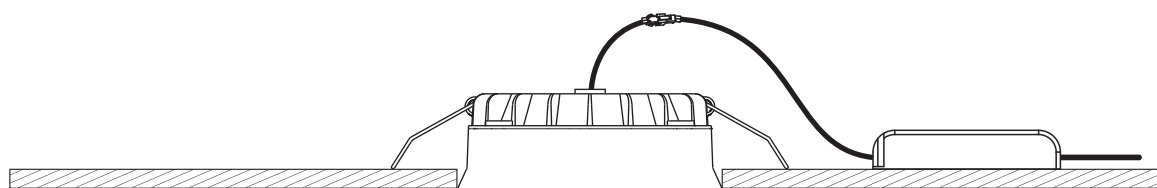

## Warnings:

1. Make sure that the product is installed properly before connecting to electricity.
2. Do not cover the fitting.
3. Maintenance and installation should only be carried out by a professional electrician.